

A=25 ft<sup>2</sup>  
**TYPE I 18'-0" ARROW**

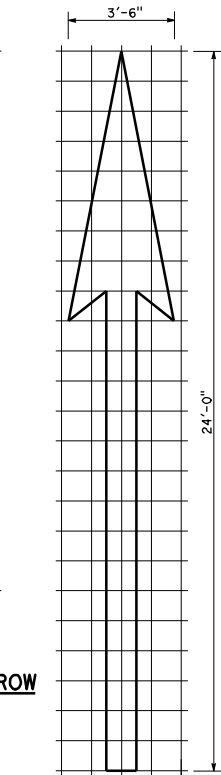

A=31 ft<sup>2</sup>  
**TYPE I 24'-0" ARROW**

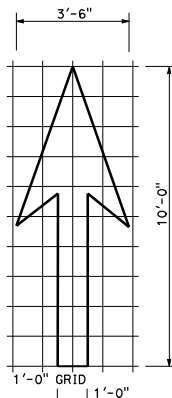

A=14 ft<sup>2</sup>  
**TYPE I 10'-0" ARROW**

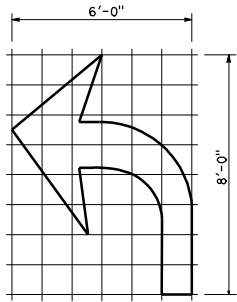

A=15 ft<sup>2</sup>  
**TYPE IV (L) ARROW**  
(For Type IV (R) arrow, use mirror image)

**NOTE:**  
Minor variations in dimensions may be accepted by the Engineer.

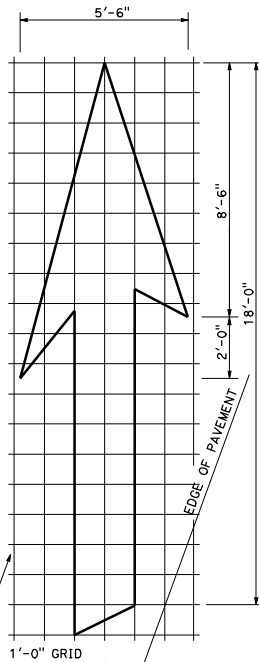

A=42 ft<sup>2</sup>  
**TYPE VI ARROW**  
Right lane drop arrow  
(For left lane, use mirror image)

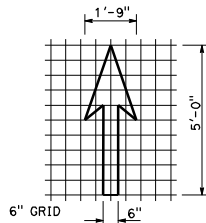

A=7 ft<sup>2</sup>  
**BIKE LANE ARROW**

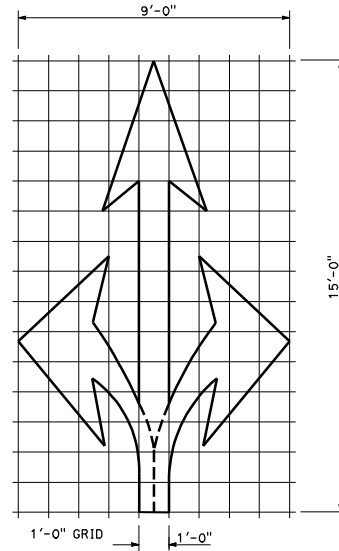

A=36 ft<sup>2</sup>  
**TYPE VIII ARROW**

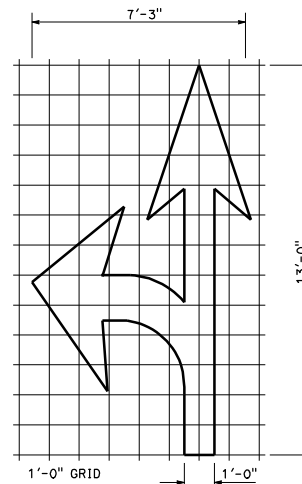

A=27 ft<sup>2</sup>  
**TYPE VII (L) ARROW**  
(For Type VII (R) arrow, use mirror image)

DIST	COUNTY	ROUTE	POST MILES TOTAL PROJECT	SHEET NO.	TOTAL SHEETS

**Roberto L. McLaughlin**  
 REGISTERED CIVIL ENGINEER  
 No. C40375  
 Exp. 3-31-13  
 CIVIL  
 STATE OF CALIFORNIA

May 20, 2011  
 PLANS APPROVAL DATE  
 THE STATE OF CALIFORNIA OR ITS OFFICERS OR AGENTS SHALL NOT BE RESPONSIBLE FOR THE ACCURACY OR COMPLETENESS OF SCANNED COPIES OF THIS PLAN SHEET.

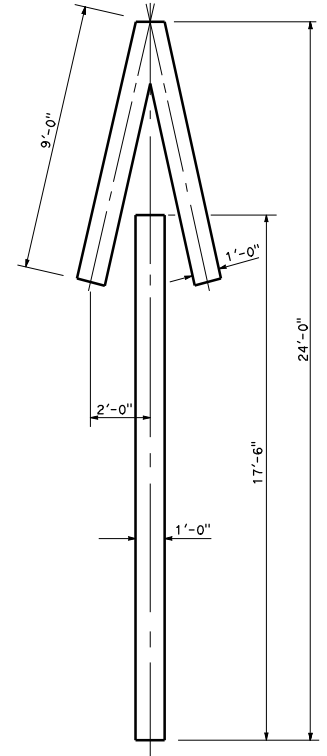

A=33 ft<sup>2</sup>  
**TYPE V ARROW**

STATE OF CALIFORNIA  
DEPARTMENT OF TRANSPORTATION

**PAVEMENT MARKINGS  
ARROWS**

NO SCALE

**A24A**